

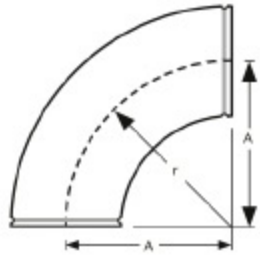

Grooved Fittings

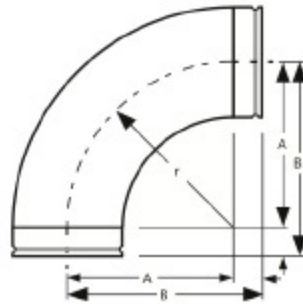

Roll grooved LR90 (no tangents)



Roll grooved LR90, long tangent

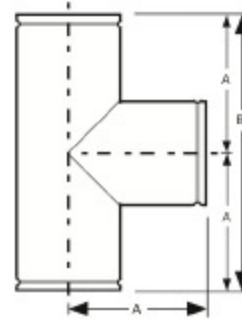

Roll grooved Tee



Roll grooved 45 (no tangents)

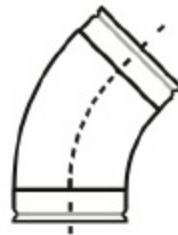

Roll grooved 45, long tangent

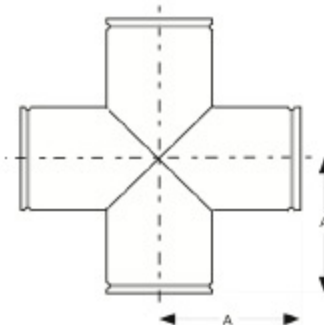

Roll grooved cross (B16.1)

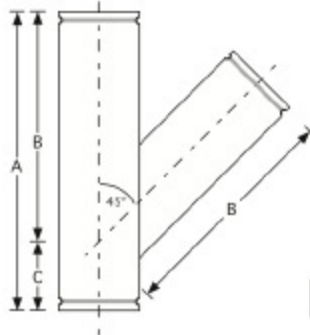

Roll grooved 45° Lateral

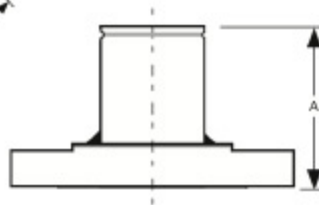

Groove x Flanged Nipple

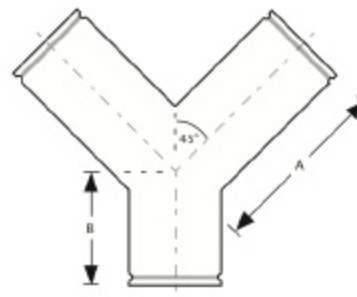

Roll grooved True Wye

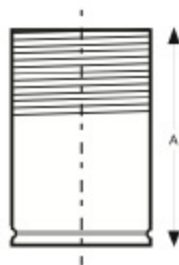

Groove x MPT Nipple

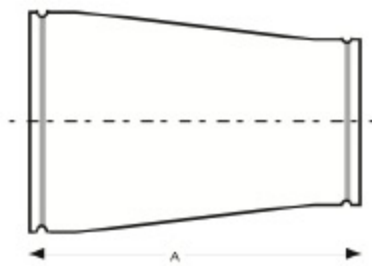

Roll grooved long tangent conc B16.1



Groove x BW Nipple

- Grooved piping systems are an alternative assembly of pipe, fittings, and clamps designed for rapid assembly/disassembly of the pipeline, oftentimes for clean-out.
- Tangents required on some fittings. Call for details.